

INSTRUCTION MANUAL

SM-603

DC12V/2.5A CE 

Contents

Contents	1
preface	2
Main features.....	2
Accessories Included.....	2
Connector assembly diagram	3
Product installation	4
Panel function	6
iPod operation instruction	7
USB functions	7
AUX functions	8
Bluetooth function.....	8
Safety affairs	9
Common problems and solutions.....	10
Technical specifications	11
Remarks	11

preface

Thank you for buying this product! We suggest that you should read the manual before connecting the system to a power supply so as to guarantee the best feature of the product and your video and audio enjoyment.

Please keep the manual and packaging carefully for later reference.

If there is problem during using the system, please contact our customer service department.

Main features

- MP3 Playback
- AUX input function
- Bluetooth function
- USB playback, and Phone charging function
- iPod/iPhone/iPad playback and charging function
- 2.1 track power output(2 x 6 W + 12W RMS)

Accessories Included

Please check that the following accessories are included in the package.

1. User's manual

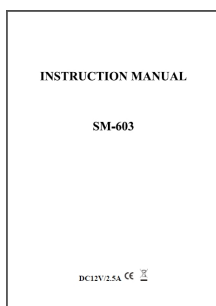

2. 3.5mm Audio Cable



3. DC socket line



4. Power adaptor

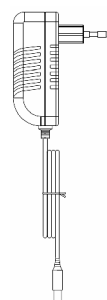

Before attempting to connect, operate or adjust this product, please read the instructions completely.

Please save this manual.

Connector assembly diagram

Connection instructions

- 1.connecting line ① :Connect the subwoofer
- 2.connecting line ② :Connect the Power Plug
- 3.connecting line ③ ④ : Connect Right and left channel

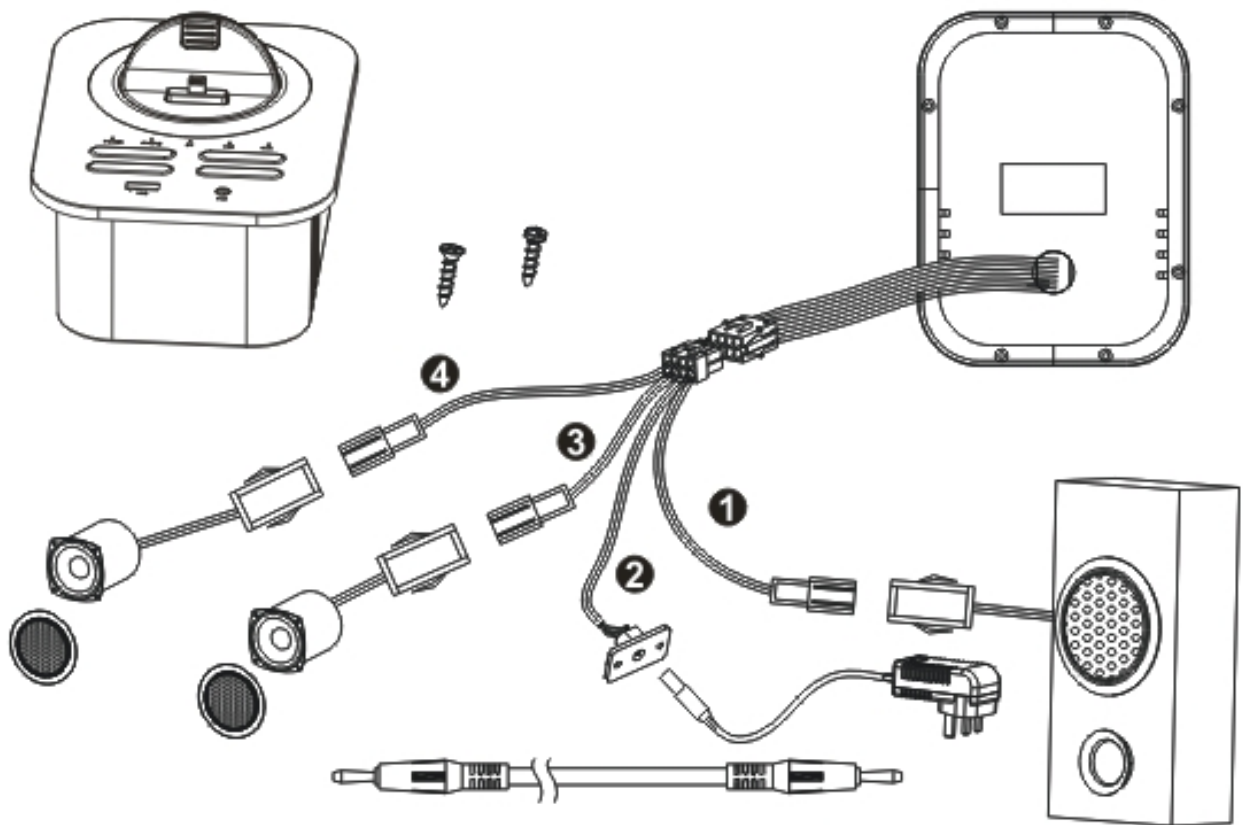

Product installation

These illustrations are for the smart audio system installation, just for your reference.

The style of sofa is not limited, each parts of the audio should be installed in the corresponding position of the sofa. The appearance and the installation steps will be slightly different due to different models.

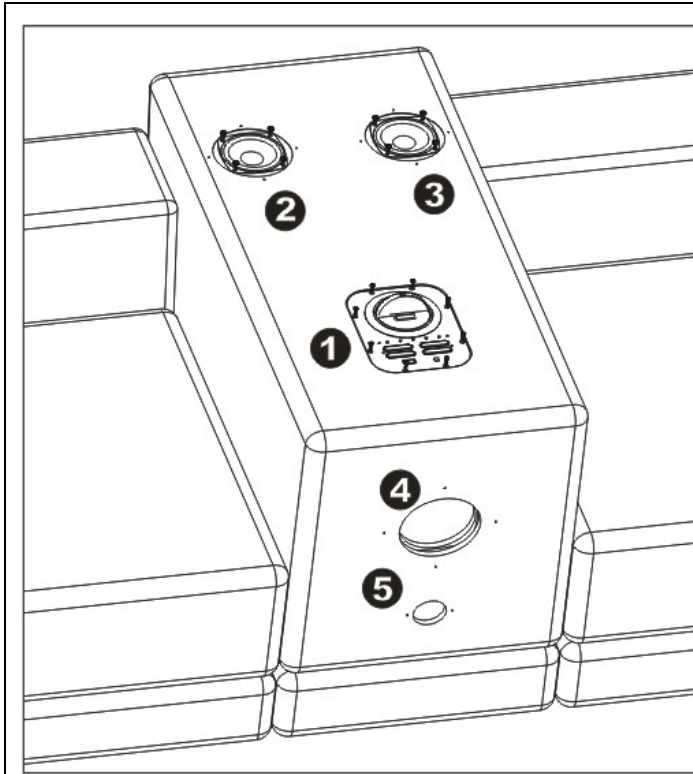

Position ① : Main module;
Positions ②③: Speaker;
Position ④ : Subwoofer;
Position ⑤: Outlet tube.

Installation steps:

1. Use the pan cross recessed head screws to install the main module in position ①, and tighten them by a screwdriver.
2. Use the cross recessed pan head screws with referral to install the speaker module in position ②③, and tighten them by a screwdriver.
3. Put the subwoofer module into position ④ of the sofa before assembling and installing the sofa, it needs to be aligned to the holes between subwoofer holes and the outlet holes.

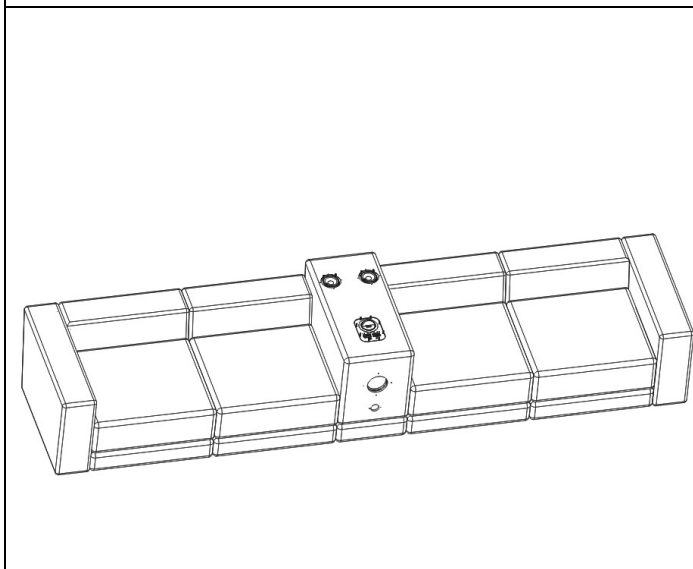

4. Tear off the barrier paper on the cover, paste the cover onto the surface of the main module and fasten them together.

5. Install the outlet tube in position ⑤, use the pan cross recessed head screws to fix them together and make sure they are sealed.

6. Install the speaker grilles and the decorative inner circles in position ②③④, and use the pan cross recessed head screws to fix them together.

7. Install the speaker decorative outer circles in position ②③④;



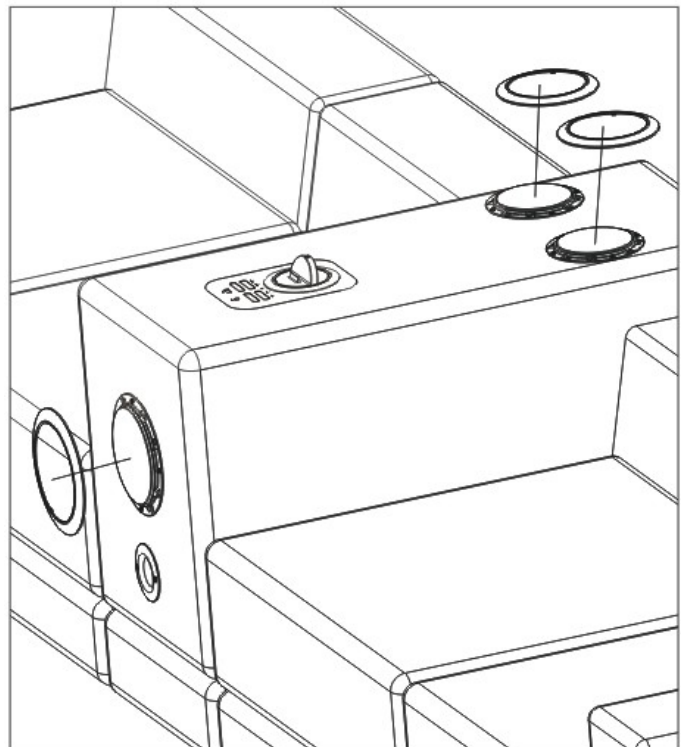
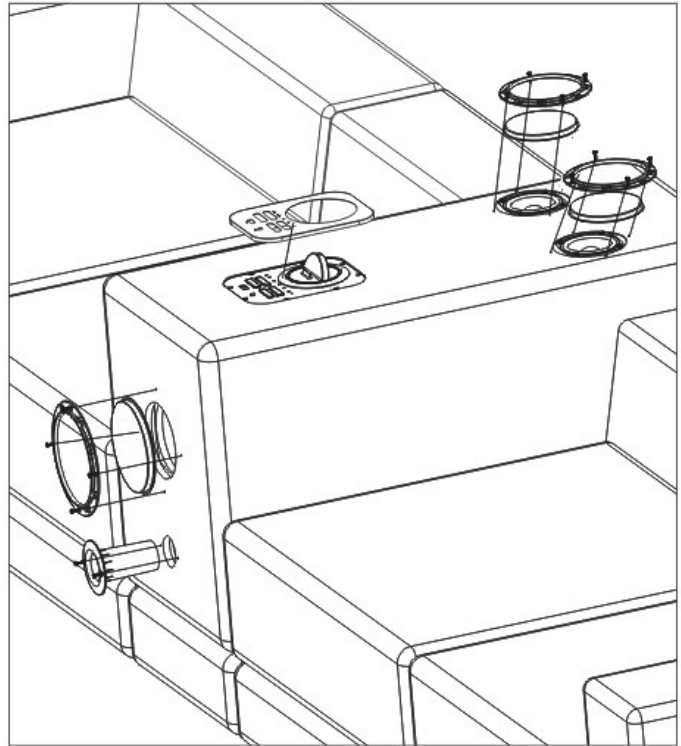



8. Installation finished. Then connect the system according to the system connection illustration manual.

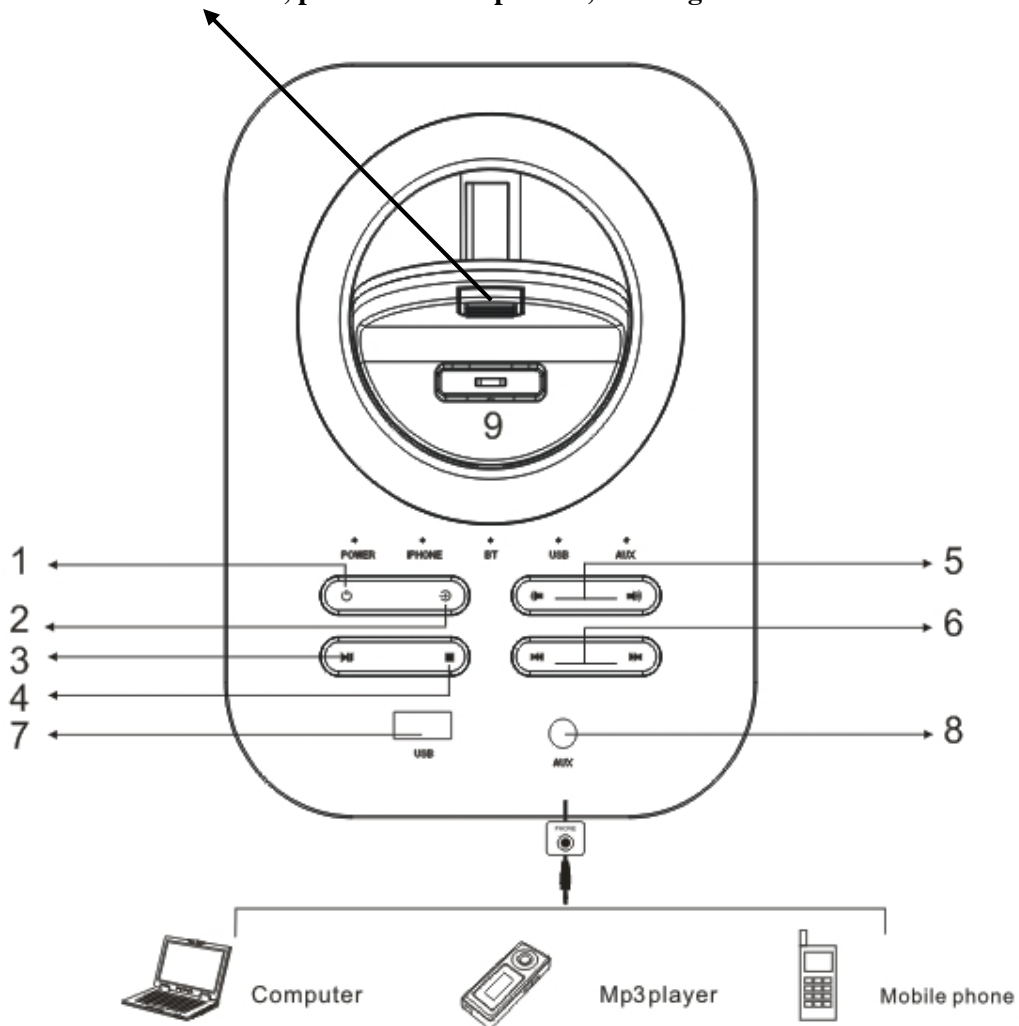

Panel function

NOTE:When not use iPod function, pull the slider upwards, rotating iPod box to cover iPod socket.



1. 	Standby
2. 	Channel conversion
3. 	Play/Pause
4. 	Stop
5. 	Main Volume
6. 	Playback: Previous/Next track
7. 	USB input
8. AUX IN	Line in jack
9. iPod/iPhone/iPad docking	

iPod operation instruction

1. In power-on mode, put the iPhone/iPod MINI 8 - pin (hereinafter referred to as the iPod devices) to the docking , the system will convert to iPod mode automatically ,and the related LED indicator is on, it will take 3-5 seconds to identify the iPod devices, after that it will enter into iPod music playback mode automatically,
2. In iPod playback .press the **▶||** button on the panel to set the iPod playback state, press once to pause, press again restored to playing state ,press the **◀◀** button or the **▶▶** button to choose previous track or next track
3. During the working state , the system can be charge the iPod devices

NOTE:

1. When playing iPod devices , sometimes it will appear that iPod devices can not be authenticated .please unplug the iPod devices and plug again or reboot the iPod devices
2. when charging the iPod devices , you need to wait 3 to 5 minutes before the iPod devices start if the battery of your iPod devices has been completely exhausted
3. The audio system are compatible with the most of popular iPod devices models , due to the different interfaces of the iPod devices , the docking are different .so the one with 30-pins and the one with 8-pins can not be compatible with at the same time , when you wan to play the 30-pins iPod , or iPhone 4 ,please use USB mode to play it

USB functions

Use U disk with USB interface to play the songs.

1. Press the “” key on the front panel or the “USB” key on the remote to enter the USB mode.
2. Input the USB, the files will be played automatically.
3. When playing USB, it is unable to navigate from one folder to another, all the files of different folders may display together, you can only use the previous/next keys or numeric keys to select the option you want to play.
4. When the files are finish playing, it may stop and return to the files menu.

NOTE: It's compatible with WMA/MP3 files.





Use iPod devices with a USB interface to play the music.

1. Press the “” key on the front panel or the “USB” key on the remote to enter the USB mode.
2. Equipment distribution with iPod cable, connect the iPod to the USB device after the socket, auto play iPod music device and charge;
3. USB interface supports a variety of audio playback and charging iPod devices, including iPod, iPhone4, iPhone4S, iPhone5, iPhone6,iPad, etc.
4. The USB interface supports charging of Android mobile phone.

AUX functions

Press  button to AUX input mode, in this way, the system can connect any 3.5mm audio output devices .

Bluetooth function

1. Press the "" button on the front panel, switch to BT mode, LED light Bluetooth icon will be flashing on the screen, Bluetooth is in search mode.
2. Turn on Bluetooth of your Bluetooth device (mobile phone, iPod, iPhone etc.), set the Bluetooth device to searching mode, when search "BT-WM1" Bluetooth , Click pairing links on the "BT -WM1", after success of connection, the bluetooth icon on the LED screen is light on .
3. After matched the bluetooth correctly , you can control external bluetooth device Play/Pause . Previous . Next by pressing the "  ,  " buttons on the front panel.
4. When Bluetooth device connected the unit . next time , when the phone is switched on , it will automatically matched the unit , no need to match again , if you want to change the bluetooth pairing, please press "" button after a few seconds , LED light bluetooth icon will flashing fast to enter into pairing mode, connecting your changed device .
5. When pairing the Bluetooth of the unit , no need enter password, if shows enter password , please view your bluetooth device instruction manual for the password.

Note:

1. This machine is equipped with Bluetooth which is compatible with most Bluetooth devices and playback function. If the device does not fit or in case of bad connection, check that your Bluetooth device supports Bluetooth and functioning normally.
2. This machine can only transmit Bluetooth audio input and it does not work for video files.

Safety affairs

Safety Precautions



WARNING
RISK OF ELECTRIC SHOCK
DO NOT OPEN



The lighting flash with an arrowhead symbol, within the Equilateral triangle, is intended to alert the user to the Presence of un-insulated “dangerous voltage” within the Product’s enclosure that may be of sufficient magnitude to cause an electric shock.

WARNING: TO REDUCE THE RISK OF ELECTRIC SHOCK, DO NOT REMOVE COVER (OR BACK). NO USER.SERVICEABLE PARTS INSIDE REFER SERVICING TO QUALIFIED SERVICE PERSONNEL



The exclamation mark within the equilateral triangle is intended to alert the user to the presence of important operating and maintenance (servicing) Instructions in this user manual.

WARNING: TO PREVENT FIRE OR SHOCK HAZARD, DO NOT EXPOSE THIS APPLIANCE TO RAIN OR MOISTURE.

CAUTION: TO PREVENT ELECTRIC SHOCK.MACTCH VDE 2-ROUND PIN PLUG CAREFULLY.FULLY INSERTS.

DANGER OF EXPLOSION IF BATTERY IS INCORRECTLY REPLACED.REPLACE ONLY WITH THE SAME OR EQUIVALENT TYPE

<p>In order to avoid accidents, do not open the cover, and refer to a professional when the system needs servicing.</p>	<p>When using the machine, if smoke appears, or if there is a peculiar smell please turn off the power, pull out the socket, and ask professional to repair it.</p>	<p>Keep the machine away from containers holding liquid. If the liquid enters into the machine. It may be damaged.</p>	<p>Do not expose the machine to dust or damp. Do not place it near a lamp.</p>
<p>When there are thunderstorms. Please turnoff the machine to Avoid an accident.</p>	<p>If the machine will not be used for a long time, please unplug the power.</p>	<p>Put the machine in a Well-ventilated place, in order to reduce heat. Keep the machine far away from heat, fire, or other similar heat sources.</p>	<p>Pull out the plug before Cleaning the surface of the machine. It can be cleaned with a damp cloth and soap.</p>

Common problems and solutions

When a failure occurs, please refer to the following solutions, find out the presumable causes and solve the problem, if these are of no help, please refer to a professional.

PROBLEM	PROBLEM CAUSE	SOLUTIONS
iPod devices cannot play automatically	iPod devices is lack of power	Please charge it for a few minutes.
	iPod devices version is too old	Please play the music manually.
No sound	Volume is too low; the Speakers are not connected well	Turn up the volume, or connect the speakers well; If there is of no help, you may need to replace the speaker unit.
No response	iPod devices are not docked correctly	Please ensure your iPod devices are docked correctly, or disconnect the power and try again.
Cannot boot	Power or the socket switch doesn't turn on; the power cable is not plugging in	Turn on the switch, or plug in the power cable; if it is the problem of the power, please replace the switch power; if not, please replace a new control box.
Warning message	iPod devices are not plugging in; iPod devices are not original.	Please plug in iPod devices and ensure your iPod devices are original.
Button cannot work	Operations are too hard; the button is stuck	Please be gentle; if the button is stuck and cannot operate, please replace the control box.
Bluetooth cannot pair	Bad signal or password is not correct	Please close other pairing Bluetooth devices and reboot to pair again; Please keep the working space within 5 to 6 meters.
USB cannot work	Incompatible file format; USB device is broken or not plugging in correctly	Please confirm the format is MP3; Please ensure the USB device is working normally and plugging correctly.

Technical specifications

Power supply	12V / 2.5A	Conditions for use	Temperature: 5°C-35°C Position: Horizontal/vertical
Power	20W	N.W	3.03KG
Frequency	20Hz-20kHz±2.5db	G.W	3.36KG
SNR	> 60db[1kHz]	Size	System unit: 385x200x225mm
Audio scope	350Hz-16KHz		

Remarks

1. iPod devices is not included.
2. Please don't use the unauthorized iPod devices in this product; we decline liability for any damage or accident derived from any use of this product which is not in conformity with the instructions contained in this booklet.
3. The control system of this product is microprocessor, due to disturbing from outside or operating inappropriate when using, it may work irregular, please turn off the power and turn on again into normal working, it's not belong any question.



If at any time in the future you should need to dispose of this product, please note that waste electrical products should not be disposed of with household waste. Please recycle where facilities exist. Check with your Local Authority or retailer for recycling advice.(Waste Electrical and Electronic Equipment